

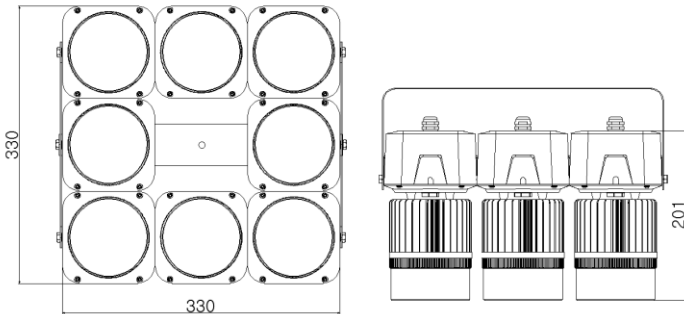

Product Description

- System Input Power: 504W
- Efficacy: 100 lm/W
- Input Frequency(Hz): 50/60Hz

Dimensions



Product Specification

モデル名	HBM8-5040F50
全光束(lm)	50400 lm
消費電力	504W
力率	> 0.9
高効率(lm/W)	100 lm/W
色温度(K)	5000K
演色性(Ra)	TYP 75
照射角	75°
定格入力電圧(V)	100 - 277Vac
使用温度	-20°C~45°C
※ Tolerance Range : ± 10%	

Physical Info

サイズ(mm)	330x 330 x 201
発光面(mm)	Ø 98*8
製品重量	< 16kg

Light Distribution & Distance Luminary – HBM8-5040F50

